

# 1440nm Butterfly FBG Laser Diode

up to 150mW, SM, PM



DATASHEET

[Return to the Webpage](#)

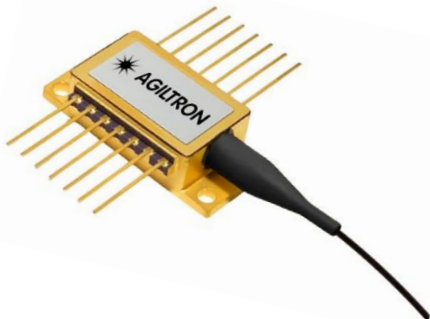

The 1440nm series laser diodes are fabricated in a hermetically sealed 14-pin butterfly package. The laser diodes contain a monitor photodiode, thermoelectric cooler (TEC), and a thermistor to secure high-quality laser performance. Our laser products are Telcordia GR-468 qualified and in compliance with RoHS Directives.

A matching driver is available in either a compact module or benchtop turn-key unit.

- FBG wavelength stabilized single mode laser.
- CW or pulsed operation.
- Low threshold current and high slope efficiency
- Operating temperature range -40°C to +50°C.
- Wavelength/temperature coefficient 0.01 nm/°C
- Built-in monitor photodiode, thermo-electric cooler and thermistor.
- Single mode (Corning SMF-28, NA=0.14, MFD=8.2um) or Polarization maintaining (Corning PM14xx, MFD=9.8+/-1um) fiber pigtail.
- Optional FC/APC connector.

## Features

- Up to 150mW
- Industry Standard 14-pin Butterfly Package
- High Reliability
- RoHs
- Telcordia GR468

## Applications

- Instrument
- Fiberoptic Sensor

## Specifications

Parameter	Min	Typical	Max	Unit
Threshold Current		30	50	mA
Forward Current		600	800	mA
Forward Voltage			2.5	V
Optical Output Power		150		mW
Wavelength	1435	1440	1445	nm
Wavelength Temperature Tunability		0.01		nm/°C
Spectral Linewidth (FWHM)			3	nm
Rise Time in Pulse Mode			30	ns
Monitor Current @ VrPD=5V	0.05		1.0	mA
PD Reverse Voltage		5	20	V
PD Forward Current			5	mA
TEC Current			1.5	A
TEC Voltage			3.8	V
Thermistor B Constant		3900		K
Thermistor Resistance @25°C	9.5	10.0	10.5	kΩ
Operating Case Temperature	0		+70	°C
Storage Temperature	-40		+85	°C
Lead Soldering Temperature			260 (10s)	°C



Rev 11/06/24

© Photonwares Corporation

[+1 781-935-1200](tel:+17819351200)

[sales@photonwares.com](mailto:sales@photonwares.com)

[www.agiltron.com](http://www.agiltron.com)

# 1440nm Butterfly FBG Laser Diode

up to 150mW, SM, PM



## DATASHEET

### Mechanical Dimension (mm)

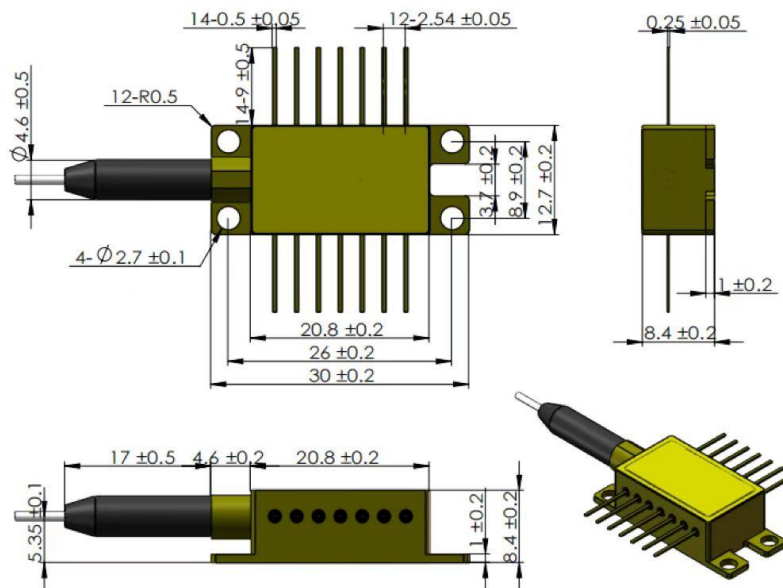

\*Product dimensions may change without notice. This is sometimes required for non-standard specifications.

### PIN Assignment

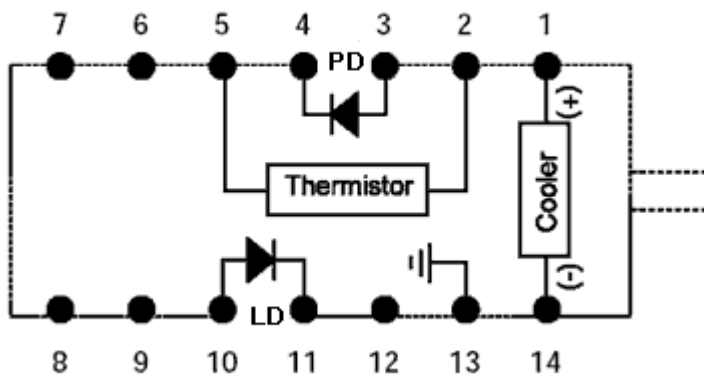

PIN	Function
1	Thermoelectric Cooler (+)
2	Thermistor
3	Monitor PD Anode (-)
4	Monitor PD Cathode (+)
5	Thermistor
6	NC
7	NC
8	NC
9	NC
10	Laser Anode (+)
11	Laser Cathode (-)
12	NC
13	Case Ground
14	Thermoelectric Cooler (-)

# 1440nm Butterfly FBG Laser Diode

up to 150mW, SM, PM



## DATASHEET

### Typical Spectrum

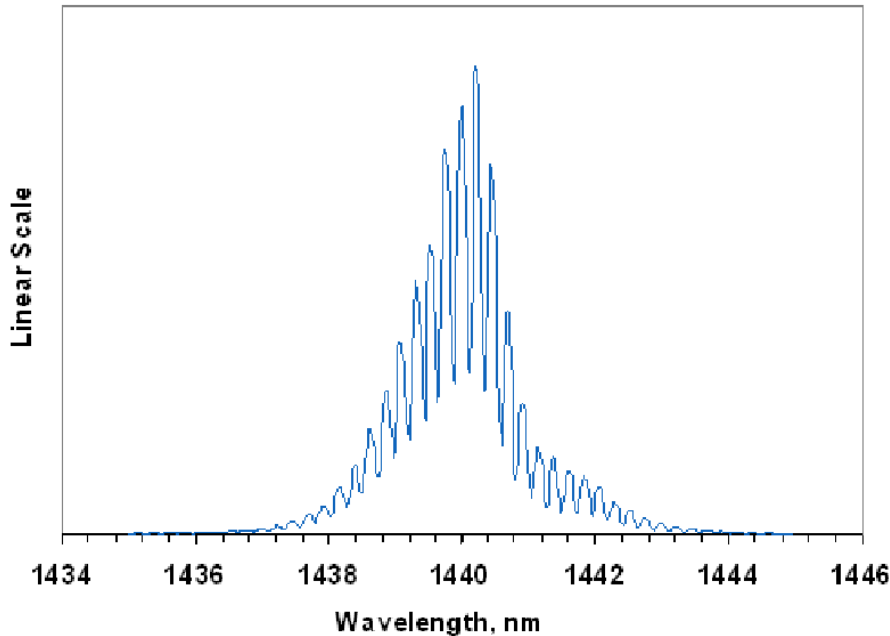

### Ordering Information

Prefix	Wavelength	Output Power	Linewidth	TEC Cooling	PD	Fiber Type	Fiber Buffer	Fiber Length	Connector
<input type="checkbox"/>	<input type="checkbox"/>	<input type="checkbox"/>	<input type="checkbox"/>	<input type="checkbox"/>	<input type="checkbox"/>	<input type="checkbox"/>	<input type="checkbox"/>	<input type="checkbox"/>	<input type="checkbox"/>
<b>FBGD-</b>	1440nm = E4 Special = 0	150mW = A	3nm = 1	Yes = 2	None = 1 Yes = 2	SM28 = 1 PM1550 = 5 50/125 = M Special = 0	0.9mm Tube = 3 Special = 0	1.0 m = 1 Special = 0	FC/APC = 3 Special = 0

# 1440nm Butterfly FBG Laser Diode

up to 150mW, SM, PM



DATASHEET

## Benchtop Matching Laser Diode Driver



Agiltron cost-effective LDCB series benchtop control kit is designed for easy laser diode mounting and precise control. It incorporates a high-precision, low-noise auto-feedback drive electronics to ensure constant output power or a constant driving current and an integrated temperature control unit maintains optimal operating conditions. The system provides up to 1A driving current and up to 2A TEC cooling current. Each system features a front fiber output connector. The user interface includes an intuitive LCD display for independent control of output power and temperature via two front rotating knobs. The LDCB also includes a universal power supply compatible with 100 to 240 VAC. The LDCB has a built-in isolator option to prevent reflection-induced laser emissions instability. The LDCB is designed as a laser diode and TEC controller kit for customer to install laser diode. It has three types of pluggable laser mounts of butterfly, DIL, and TOCAN. The TOCAN mount contains an external TEC that maintains a constant temperature for wavelength stability.

For details please click: <https://agiltron.com/product/laser-diode-tec-controllers-benchtop-kit/>

## Turn-Key Module Matching The Laser Diode



The Agiltron LDCM series laser source module is designed for OEM applications and features all-in-one high reliability and highly stable laser output. The LDCM contains high-precision, low-noise, auto-feedback laser diode drive electronics to ensure constant output power or driving current and an integrated temperature controller that maintains optimal operating conditions. An optional fiber optical isolator can be integrated to prevent reflection-induced laser emission instability, which is essential for achieving highly stable lasers. Agiltron produces isolators from 370nm to 2600nm. The system provides up to 1A driving current and up to 2A TEC cooling current. Each unit features a single FC/APC connector output and two front rotating knobs for independent setting of laser output power and temperature. A toggle switch allows selection between constant current control mode and feedback constant output power mode.

For details please click: <https://agiltron.com/product/laser-diode-tec-controllers-module/>

## Laser Driver Kit



Agiltron cost-effective LDCD series module control kit is designed for easy laser diode mounting and precise control. It incorporates a high-precision, low-noise auto-feedback drive electronics to ensure constant output power or a constant driving current and an integrated temperature control unit maintains optimal operating conditions. The system provides up to 1A driving current and up to 2A TEC cooling current. It has three types of pluggable laser mounts of butterfly, DIL, and TOCAN. The TOCAN mount contains an external TEC that maintains a constant temperature for wavelength stability. It comes with cables to connect between the mounting module to the driving module, making integration convenient.

For details please click: <https://agiltron.com/product/laser-diode-tec-controllers-compact/>

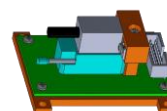
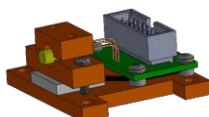
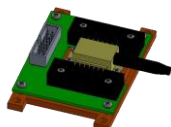

# 1440nm Butterfly FBG Laser Diode

up to 150mW, SM, PM



DATASHEET

## Caution Electrostatic Sensitivity



- Never touch laser diode and the module using hands
- Always use protections when handle a laser diode
- Recommend mounting the laser diode using an ionic gun and ESD finger cots



## Laser Safety

This product meets the appropriate standard in Title 21 of the Code of Federal Regulations (CFR). FDA/CDRH Class 1M laser product. This device has been classified with the FDA/CDRH under accession number 0220191. All versions of this laser are Class 1M laser products, tested according to IEC 60825-1:2007 / EN 60825-1:2007. An additional warning for Class 1M laser products. For diverging beams, this warning shall state that viewing the laser output with certain optical instruments (for example eye loupes, magnifiers, and microscopes) within a distance of 100 mm may pose an eye hazard. For collimated beams, this warning shall state that viewing the laser output with certain instruments designed for use at a distance (for example telescopes and binoculars) may pose an eye hazard.

Wavelength = 1.3/1.5  $\mu\text{m}$ .

Maximum power = 30 mW.



\*Caution - Use of controls or adjustments or performance of procedures other than those specified herein may result in hazardous radiation exposure.

\*IEC is a registered trademark of the International Electrotechnical Commission.